

# PIEZO MATERIAL SHAPE AND DIMENSION

DISC

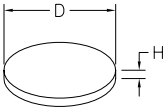

TUBE

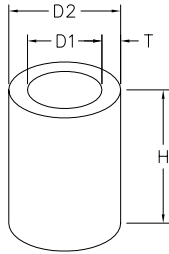

PLATE

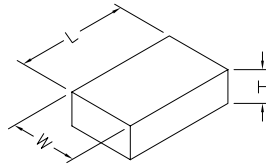

SPHERE

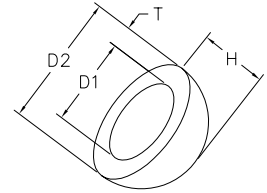

## YOUR PRODUCT SELECTION

Geometry	Size (Inch)	Tolerance(Inch)	Notes
<b>Disc</b>	D:		
	H:		
<b>Tube</b>	D1:		
	D2:		
	H:		
	T:		
<b>Plate</b>	L:		
	W:		
	H:		
<b>Sphere</b>	D1:		
	D2:		
	H:		
	T:		
<b>Other</b>			

# FLEXURAL COMPONENTS

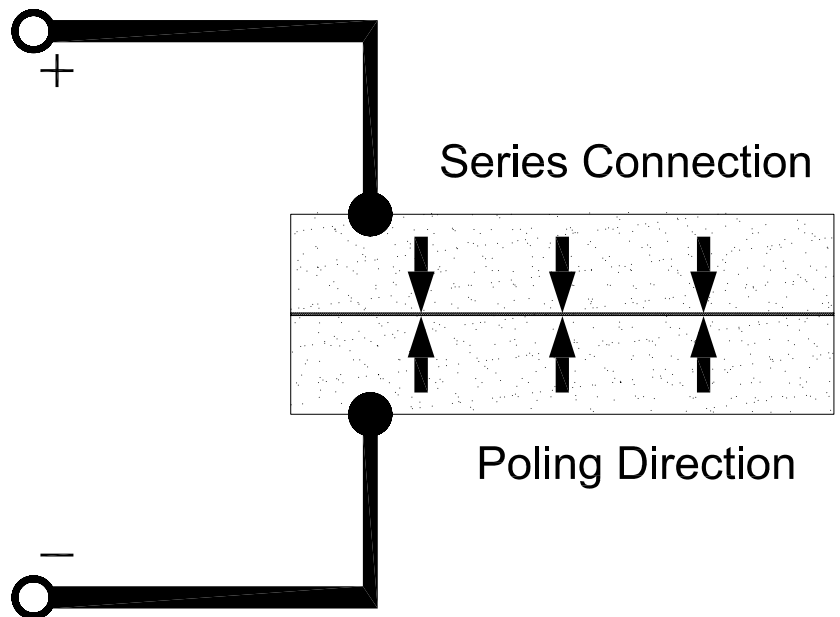
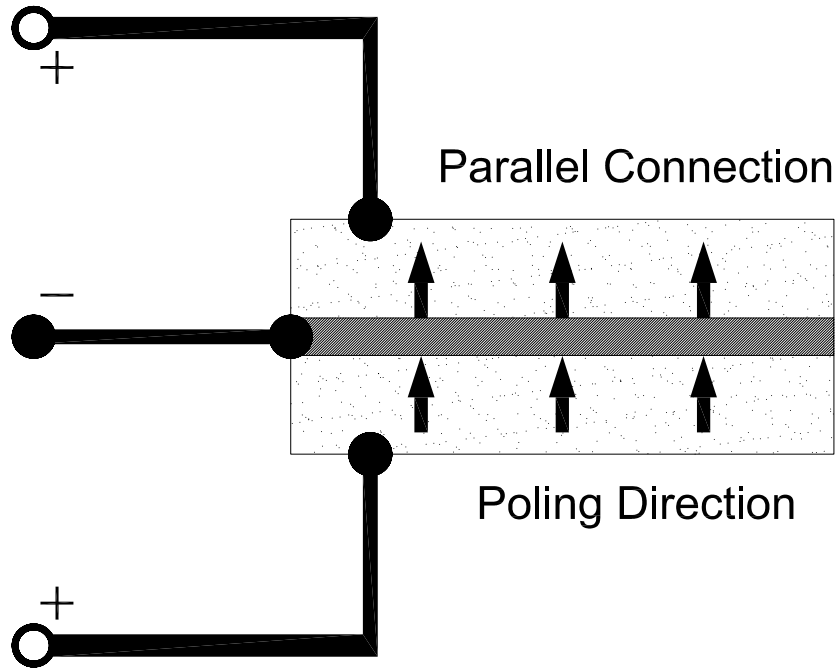

# TUBES WITH SEGMENTS OF ELECTRODE

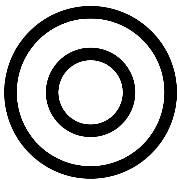

Full Electrode

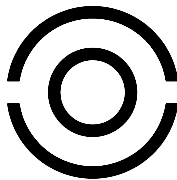

Two Segments  
On Outer  
Electrode

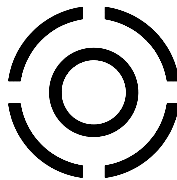

Four Segments  
On Outer  
Electrode



Full Electrode



Two Segments  
On Outer  
Electrode



T Shape  
On Outer  
Electrode